

9 RESILIENT FLOORING
treads & nosing

The R. C. Musson Rubber Co.
February 2012

MUSSON

Stair Coverings
Entry Flooring
Floor Coverings
Raised Design Tile

09 65 00/MUS
BuyLine 0269



INDOOR



OUTDOOR

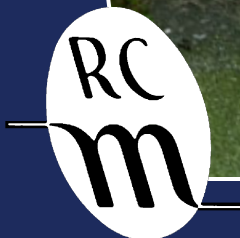

MUSSON RUBBER CO.

Over 65 Years
www.mussonrubber.com

For entrance mats, matting or tile, see Sweet's 12 48 13/MUS

MR/MANUFACTURER

Musson has been a pioneer and leader in the development, manufacture and distribution of safety stair coverings and flooring materials. Here is the most complete and comprehensive line of top quality rubber stair coverings for use in public buildings. These products along with rubber and vinyl matting have been produced since 1945.

DT/DOCUMENT

This brochure provides detailed specifications covering Musson rubber safety stair treads, risers, landing material, tile, rubber floor covering, raised design tile, grit-strips, and adhesive to help the architect, engineer, builder, and owner in the proper application and use of stair covering and related floor accessories. These products are suited for new installation or replacement of existing.

UA/USES, APPLICATION

Include Musson safety stair coverings in plans for all public buildings, schools, churches, hotels, restaurants, theatres, office buildings, apartments, factories, institutions, hospitals; any place where pedestrian traffic moves in a commercial building. Many styles, designs and thicknesses offer durability, ease of maintenance, an attractive appearance, and make stairways safer. Unless otherwise specified, all products are intended for interior use.

SPECIAL INFORMATION

Most molded rubber treads run slightly longer than the standard size listed, but not a uniform overage. Many sizes are produced by blocking a mold, leaving one end unfinished and untrimmed. If you are butting treads end to end to cover extra wide steps, you must so specify on your order so we can ship treads all made from the same mold. We cannot guarantee exact shade, gauge or Grip-Strip alignment. Molded rubber treads are sanded on the back edge to give better adhesion; they are not sanded to an exact thickness. Butting of matching tile or flooring to the back of treads may require sanding of the treads or tile/flooring to match butt edges.

All molded rubber stair covering materials listed in our catalog are supplied with sanded backs for ease in installation and better adhesion.

Product colors are reproduced as accurately as possible. Final color selection should be made from actual samples.

Physical properties of molded rubber products have been tested under ASTM-D471; ASTM-D624 (Die C); ASTM-D2047; ASTM 2240 (Shore A); ASTM E392-73t; ASTM-E648; ASTM-E662; ASTM-E84; MIL-1 -631 D; F.S.501 a, method 6261; RR-T-650e; and SS-T-312B.

FLAME SPREAD CLASSIFICATION

All molded rubber stair coverings and molded rubber floor coverings have been tested in accordance with and meet or surpass the listed requirements of the following tests:
 UL 992 Chamber Test 2.0 or less
 ASTM-E84 Tunnel Test 75 or less
 NFPA 253 C.R.F. Test .9 Watts/square centimeter or more

INDEX

	Page
Color Charts	2t
Disc-O-Tile & Disc-O-Treds	3t
Design Rubber Stair Treads	4t
Design, Smooth & Grit Strip Rubber Stair Treads . .	5t
Rubber Riser, Sheet & Landing Tiles	6t
Outdoor Rubber Treads; Aluminum stair Treads	7t
Uno-Tred & Uno-Tile	8t

WARRANTY

Musson warrants all rubber stair treads and raised pattern landing tiles against excessive wear for a period of 5 years; sheet rubber and smooth tile for a period of 10 years; all other products for a period of 1 year. Contact Musson for restrictions and complete warranty details.

COLOR SERIES I

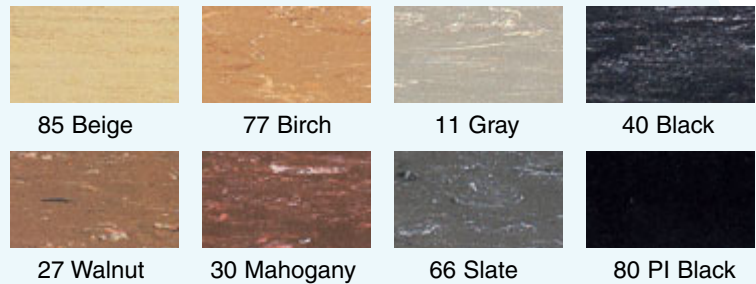

COLOR SERIES II

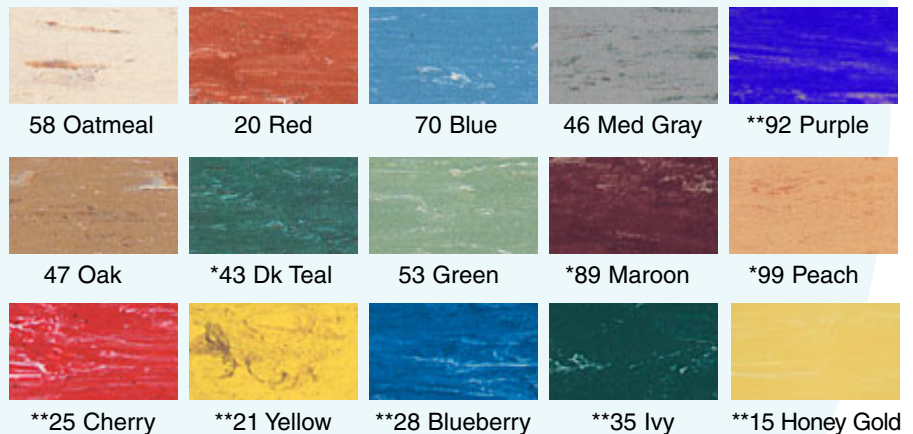

** Not available in all product lines; minimum quantity runs may apply.

COLOR SERIES III



(Product colors are reproduced as accurately as possible. Make final color selection from actual samples.)

* non-standard colors which may require a minimum quantity run.

DISC-O-TILE® DESIGN RUBBER FLOOR TILE

No. 788

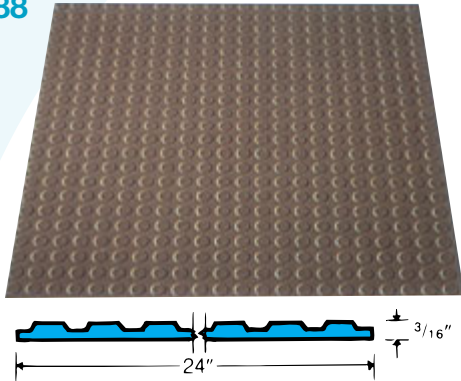

This unique floor tile with raised circular discs (3/4" diameter), for better traction; is attractive, non-staining and non-discoloring. Factory cut 24" x 24" square tiles mean quick installation, fewer joints. Circular discs allow for easy cleaning. Wheeled equipment moves across easily. Ideal for stair landings, lobbies, entrances, elevators, hallways, ramps; around concessions or vending machines. Install with Musson Epoxy adhesive.

Specifications: Furnish and install No. 788 Disc-O-Tile Design Rubber Floor Tile by Musson Rubber Co., Akron, Ohio; 3/16" thick; 24" x 24" square tile size. Tile shall have a Flame Spread Rating of 25 or less using ASTM-E-84 Test. Tile shall have a sanded back to assure proper adhesion; contain no asbestos fiber; made of top quality properly cured homogenous rubber compound, color extending throughout thickness; free from objectionable odors or imperfections which might impair serviceability. Select standard solid color from Color Series III on page 2t.

DISC-O-TRED® DESIGN RUBBER STAIR TREADS

No. 787

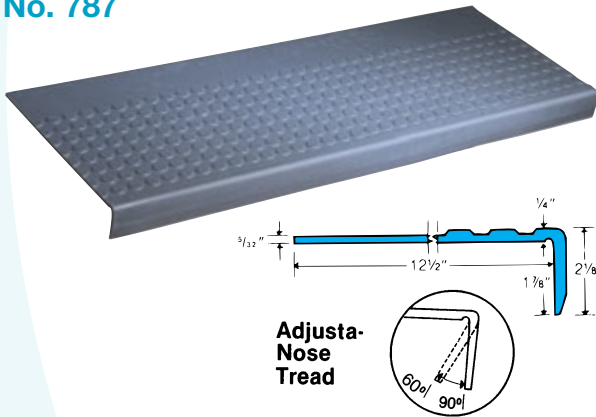

Our Adjusta-Nose design easily adjusts to steps with angle nosings between 90° and 60°; allows fit on stairways designed for safety or aesthetics. Ideal for public buildings where fire-safety is a prime prerequisite; durable for heavy traffic areas. Circular discs (3/4" diameter) are easy to clean, affords safer pedestrian traffic. Meets Federal Specs. RR-T-650E. Install with No. 400 Neoprene Contact Adhesive or No. 300 Stair Tread Adhesive, back of tread and back of nosing; use No. 110 Epoxy Stair Caulk inside of nose.

Specifications: Furnish and install No. 787 Disc-O-Tred Stair Treads by Musson Rubber Co., Akron, Ohio; 1/4" thick tapering to back edge; 12-1/2" deep. Treads shall have a Flame Spread Rating of 25 or less using ASTM-E-84 Test; an adjustable square nose (1-7/8" deep); a sanded back to assure proper adhesion; contain no asbestos fiber; made of top quality homogenous rubber compound, color extending throughout thickness; free from objectionable odors or imperfections which might impair serviceability. Select standard length of 36", 42", 48", 54", 60" or 72". Select standard solid color from Color Series III on page 2t.

No. GS787 Grit Strip Disc-O-Tred — available with two abrasive Grit-Strips recessed and bonded in machine ground grooves at the impact point of pedestrian traffic.

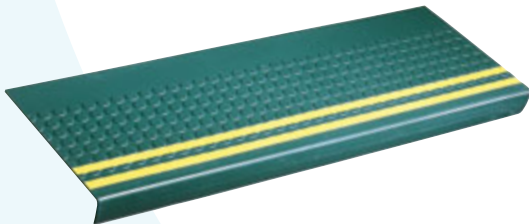

Specifications: Furnish and install No. GS787 Grit-Strip Disc-O-Tred Stair Treads by Musson Rubber Co., Akron, Ohio; 1/4" thick tapering to back edge, 12-1/2" deep, with two black* 3/4" wide abrasive grit-strips inlaid in tread 1" from front edge, spaced 3/4" apart. Treads shall have a Flame Spread Rating of 25 or less using ASTM-E-84 Test; an adjustable square nose (1-7/8" deep), a sanded back to assure proper adhesion; contain no asbestos fiber; made of top quality homogenous rubber compound, color extending throughout thickness; free from objectionable odors or imperfections which might impair serviceability. Select standard length of 36", 42", 48", 54", 60" or 72". Select standard solid color from Color Series III on page 2t.

No. GS787VI Grit-Strip Disc-O Tred — available with one 2" abrasive Grit-Strip (for Visually Impaired) recessed and bonded in machine ground groove at the impact point of pedestrian traffic.

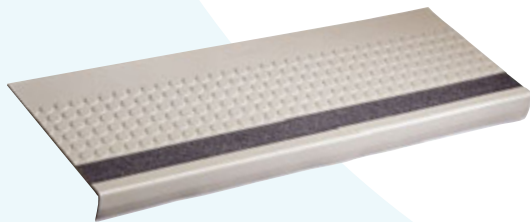

Specifications: Furnish and install No. GS787VI Grit-Strip Disc-O-Tred Stair Treads by Musson Rubber Co., Akron, Ohio; 1/4" thick tapering to back edge, 12-1/2" deep, with one black* 2" wide abrasive grit-strip inlaid in tread, 1" from front edge, for access by Visually Impaired. Treads shall have a Flame Spread Rating of 25 or less using ASTM-E-84 Test; an adjustable square nose (1-7/8" deep), a sanded back to assure proper adhesion; contain no asbestos fiber; made of top quality homogenous rubber compound, color extending throughout thickness; free from objectionable odors or imperfections which might impair serviceability. Select standard length of 36", 42", 48", 54", 60" or 72". Select standard solid color from Color Series III on page 2t.

*Grit Strip inserts are available in Black, Brown, Gray, Beige, Safety Yellow or Safety Red. See Page 5t.

MATCHING COVERED RISERS:



Style No. 505-CR; 7" high molded covered risers also available in same special compound; same standard lengths and colors as stair treads. Risers have a 5/8" toe, are approximately 1/8" thick.

(No. 786-R smooth flat risers and stringers of same special compound are available in 1/8" thick x 6", 7", 8", 9", 10" or 12" width; cut to exact lengths to 12 feet maximum; in matching colors).

All items listed on this page fully meet the ASTM-E84 Flame Spread Rating of 25 or less.

No. 622

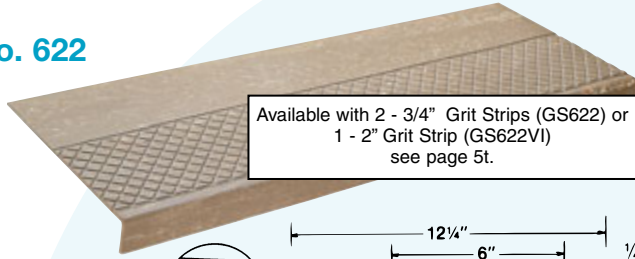

Available with 2 - 3/4" Grit Strips (GS622) or 1 - 2" Grit Strip (GS622VI) see page 5t.

Adjusta-Nose Tread

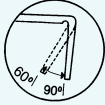

Adjusta-Nose design will easily adjust and adhere to steps with return angle nosings between 90° and 60°; allows good fit on stairways designed for safety or aesthetics.

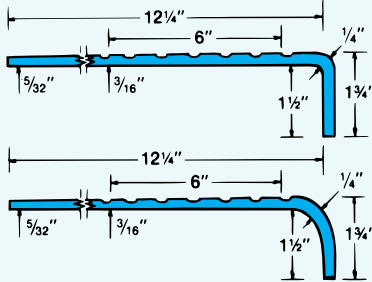

The original molded rubber diamond design stair tread – half diamond design, half smooth; with a longer adjustable nose to fit pan filled, molded concrete or terrazzo steps. Use in commercial, industrial or institutional buildings. Diamond design surface is 6" deep, covers impact area of pedestrian traffic. Meets Federal Specs. RR-T-650E and ZZ-T-001237(GSA-FSS). Install with Musson #400 Neoprene Contact Adhesive, #300 Stair Tread Adhesive or #560 Rubber Flooring Adhesive; use #110 Epoxy Nose Caulk for longer wear and added safety.

Specifications: Furnish and install No. 622 Diamond Design Stair Treads from Musson Rubber, Akron, Ohio; 1/4" thick, tapering to back edge, 12-1/4" deep. Treads shall have a 1-1/2" adjustable square nose (or curved nose); a Flame Spread Rating of 75 or less using ASTM-E-84 Test; a sanded back to assure proper adhesion; contain no asbestos fiber; molded of top quality homogeneous rubber compound, color extending throughout thickness; free from objectionable odors, blisters, cracks or imperfections which might impair serviceability. Select standard length of 36", 42", 48", 54", 60" or 72"; Select standard color from Color Series I, II, or III on page 2t. (Curved Nose available only in Color Series I.)

No. 800

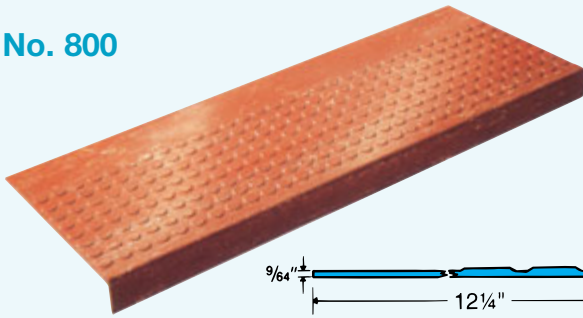

Available with 2 - 3/4" Grit Strips (GS800) or 1 - 2" Grit Strip (GS800VI) see page 5t.

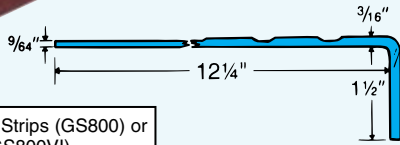

Our Lo-Disc Stair Tread has the ever popular round disc design in a lighter gauge stair tread. Lo-Disc Stair Treads have tapered 3/4" discs, raised .025"; are easier to keep clean. An economical, attractive, long-wearing resilient rubber stair tread with added weight at the front edge; excellent for lighter traffic stairways. Meets Federal Specs. RR-T-650E and ZZ-T-001237 (GSA-FSS). Install with Musson #400 Neoprene Contact Adhesive, #300 Stair Tread Adhesive or #560 Rubber Flooring Adhesive; use #110 Epoxy Nose Caulk for longer wear and added safety.

Specifications: Furnish and install No.800 Lo-Disc Design Stair Treads from Musson Rubber, Akron, Ohio; 3/16" thick, tapering to back edge, 12-1/4" deep. Treads shall have a 1-1/2" square nose; a Flame Spread Rating of 75 or less using ASTM-E-84 Test; a sanded back to assure proper adhesion; contain no asbestos fiber; molded of top quality homogeneous rubber compound, color extending throughout thickness; free from objectionable odors, blisters, cracks, or imperfections which might impair serviceability. Select standard length of 36", 42", 48", 54", 60" or 72"; Select standard color from Color Series I, II, or III on page 2t.

No. 500

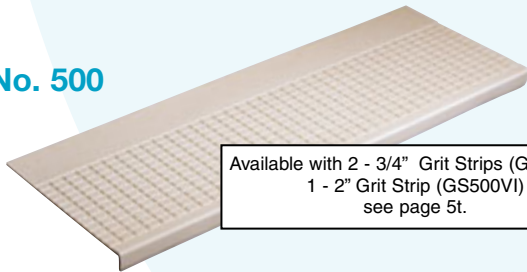

Available with 2 - 3/4" Grit Strips (GS500) or 1 - 2" Grit Strip (GS500VI) see page 5t.

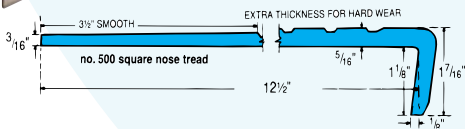

Our heaviest gauge molded rubber tread; exclusive rectangular design—for safety, durability and ease of maintenance; easily trimmed to exact size of steps. Tapered nosing insures better fit; smooth rear border facilitates cleaning. Meets Federal Specs. RR-T-650E and ZZ-T-001237 (GSA-FSS). Install with Musson #400 Neoprene Contact, #300 Stair Tread Adhesive or #560 Rubber Flooring adhesive; use #110 Epoxy Nose Caulk for longer wear and added safety.

Specifications: Furnish and install No. 500 Rectangular Design Stair Treads from Musson Rubber, Akron, Ohio; 5/16" thick, tapering to back edge; 12-1/2" deep. Treads shall have 1-1/8" square nose; a Flame Spread Rating of 75 or less using ASTM-E-84 Test; a sanded back to assure proper adhesion; contain no asbestos fiber; molded of top quality homogeneous rubber compound; color extending throughout thickness; free from objectionable odors, blisters, cracks or imperfections which might impair serviceability. Select standard length of 36", 42", 48", 54", 61" or 72"; Select standard color from Color Series I or II on page 2t.

No. 1000

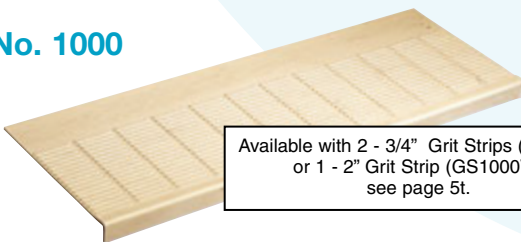

Available with 2 - 3/4" Grit Strips (GS1000) or 1 - 2" Grit Strip (GS1000VI) see page 5t.

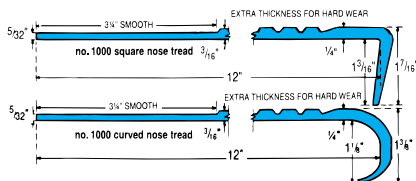

An attractive, easy to clean, horizontal bar pattern, tapered return nose for better fit. Extra thick front edge tapers to smooth rear border, makes cleaning easier. Meets Federal Specs. RR-T-650E and ZZ-T-001237 (GSA-FSS). Install with Musson #400 Neoprene Contact, #300 Stair Tread Adhesive or #560 Rubber Flooring adhesive. Use #110 Epoxy Nose Caulk for longer wear and added safety.

Specifications: Furnish and install No. 1000 Horizontal Bar Design Stair Treads from Musson Rubber, Akron, Ohio; 1/4" thick, tapering to back edge; 12" deep. Treads shall have a 1-3/16" square nose (or curved nose); a Flame Spread Rating of 75 or less using ASTM-E-84 Test; a sanded back to assure proper adhesion; contain no asbestos fiber; molded of top quality homogeneous rubber compound, color extending throughout thickness; free from objectionable odors, blisters, cracks or imperfections which might impair serviceability. Select standard length of 36", 42", 48", 54", 60" or 72"; (54", 60" and 72" available in square nose only.) Select standard color from Color Series I or II on page 2t. (Curved nose available only in Color Series I.)

No. 626

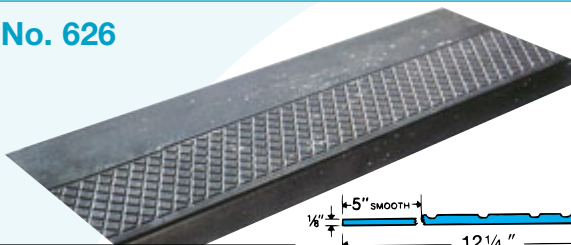

Available with 2 - 3/4" Grit Strips (GS626) or 1 - 2" Grit Strip (GS626VI) see below.

Adjusta-Nose design - will easily adjust and adhere to steps with return angle nosings between 90° and 60°; allows good fit on stairways designed for safety or aesthetics.

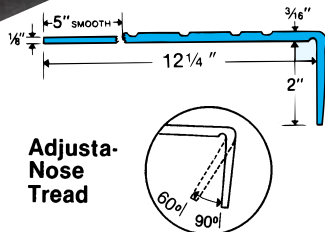

Our medium gauge Diamond Design Tread with extra long nosing for pan-filled or molded concrete steps. Not only will this 2" depth completely cover pan-filled step nosing, it adjusts from 90° to 60° to accommodate stairways with return angle nosings. Fine for all but heaviest traveled stairways. Square Adjustable Nose. Meets Federal Specs RR-T-650E and ZZ-T- 001237 (GSA-FFS).

Install with No. 400 Neoprene Contact Adhesive, #300 Stair Tread Adhesive, or #560 Rubber Flooring Adhesive. Use bead of No. 110 Epoxy Stair Caulk inside where nose joins tread.

Specifications: Furnish and install No. 626 Diamond Design Stair Treads from Musson Rubber, Akron, Ohio; 3/16" thick, tapering to back edge, 12-1/4" deep. Treads shall have a 2" adjustable square nose; a Flame Spread Rating of 75 or less using ASTM-E-84 Test; a sanded back to assure proper adhesion; contain no asbestos fiber; molded of top quality homogeneous rubber compound, color extending throughout thickness; free from objectionable odors, blisters, cracks or imperfections which might impair serviceability. Select standard length of 36", 42", 48", 54", 60" or 72"; Select standard color from Color Series I or II on page 2t.

Smooth Flat Surface



Smooth flat surface stair treads offer long wear; easy cleaning; reduce noise; marbled colors show less wear. Four styles to fit almost any stairway. Meets Flame Spread Rating of 75 or less using ASTM-E-84 Test. All treads have a sanded back for better adhesion; contain no asbestos.

Available with 2 - 3/4" Grit Strips (250/200/225) or 1 - 2" Grit Strip (250VI/200VI/225VI) see below.

Adjusta Nose design will easily adjust and adhere to steps with return angle nosing between 90° and 60°; allows for good fit on stair ways designed for safety or aesthetics.

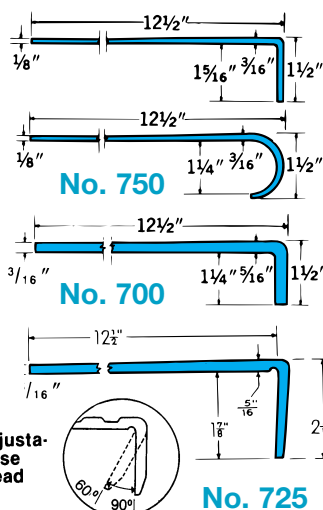

No. 750 — service weight

Specifications: Furnish and install Musson #750 Molded Rubber Smooth Flat Surface Stair Treads, 3/16" thick, tapering to back edge, 12-1/2" deep, with square (or curved) molded nose. Standard sizes: 36", 42", 48", 54", 60" or 72"; Select standard color from Color Series I or II on Page 2t.

No. 700 — heavy duty

Specifications: Furnish and install Musson #700 Molded Rubber Smooth Flat Surface Stair Treads, 5/16" thick, tapering to back edge, 12-1/2" deep, with square molded nose. Standard sizes: 36", 42", 48", 54", 60" or 72"; Select standard color from Color Series I on Page 2t.

No. 725 — heavy duty, long nose

Specifications: Furnish and install Musson #725 Molded Rubber Smooth Flat Surface Stair Treads, 5/16" thick, tapering to back edge, 12-1/2" deep with a 1-7/8" long adjustable square nose; to fit pan-filled or molded concrete steps. Standard sizes: 36", 42", 48", 54", 60" or 72"; Select standard color from Color Series I on Page 2t.

See Color Charts on Page 2t; Matching Design Tile & Accessories on Pages 6t.

Grit-Strip

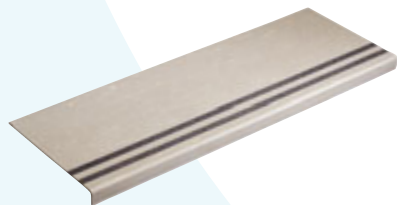

All rubber treads are available with 2 - 3/4" mineral coated Grit Strips recessed the full length of the tread at impact area and helps prevent slipping. Grit-Strip available in 6 colors.

Grit-Strip

for Visually Impaired.



All rubber treads are available with 1 - 2" mineral coated Grit Strip recessed the full length of the tread at impact area for the Visually Impaired. Grit-Strip available in 6 colors.

MUSSON GLO-STRIP®



As seen under normal light

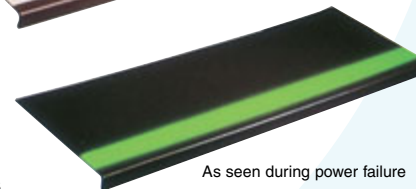

As seen during power failure

*Grit-Strip Inserts

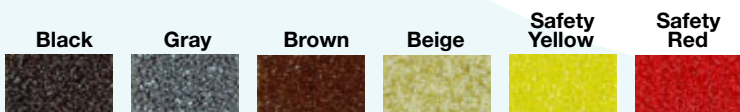

Black Color Grit Strips will be supplied unless otherwise specified.

Grit Strip inserts are available in Black, Gray, Brown, Beige, Safety Yellow or Safety Red. Any color may be inserted in any rubber tread. All strips are replaceable.

Insert Glo-Strip photoluminescent 2" Grit Strip into any rubber tread to light up steps during power outages. The recessed 2" white strip made with non-toxic, inert, zinc-sulfide crystals absorb and store light, then release this light energy in the darkness over a period of time. Recharge by exposing to light for a few minutes.

No. 505CR COVED STAIR RISER



Complete the job by specifying coved risers. Allows easier cleaning, is more attractive, reduces fitting procedures at rear of steps. 5/8" toe fits flush on top of treads. Can be trimmed to fit in height and length.

Specifications: Furnish and install Musson #505CR Molded Cove Stair Riser, 1/8" thick, 7" high, with 5/8" toe; standard lengths as needed: 36", 42", 48", 54", 60" or 72"; Select standard color from Color Series I, II or III on page 2t.

No. 500R FLAT RISERS & STRINGERS



Smooth flat risers or stringers in matching or contrasting colors to cover any riser or stringer. Supplied in roll goods, in cut pieces to fit on the job.

Specifications: Furnish and install Musson #500R Smooth Flat Rubber Stair Risers (or stringer material), 1/8" thick by standard height as needed: 6", 7", 8", 9", 10", 12" or 36"; standard lengths up to 75' in one piece; Select standard color from Color Series I or II on page 2t.

No. 500L SHEET RUBBER (39" wide)

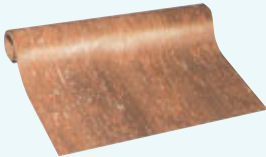

Quality sheet rubber roll goods for any size area. Excellent for heavy traffic areas in schools and hospitals. Fewer seams, fewer joints than 12"x12" tile. Contains no asbestos fiber. Complies with Federal Spec. SS-T-312B.

Specifications: Furnish and install Musson #500-L Smooth Sheet Rubber Flooring, 1/8" (or 3/32" or 3/16") thick; 39" wide roll goods with sanded back. First quality, fully homogenous to comply with Fed. Spec. SS-T-312B. Rolls contain 20 to 30 yards. Select standard color from Color Series I, II or III on page 2t.

Additional colors including Granite and Terrazzo patterns available as well as hammered finish.

For more information request our Sheet Rubber Flooring brochure.

No. 1000T RUBBER TILE (12" X 12")



Top quality smooth surface rubber floor tile. Colors extend throughout thickness for long wear and match rubber stair treads on pages 3t-5t. Offers the durable, resilient, long-wearing, easy-maintenance of rubber flooring. Contains no asbestos fiber. Meets Fed. Spec. SS-T-312B.

Specifications: Furnish and install Musson 1000-T Smooth Rubber Tile, 1/8" (or 3/32" or 3/16") thick; 12" x 12" tile size with sanded back. First quality, fully homogeneous. Select standard color from Color Series I or II on page 2t.

Additional colors including Granite and Terrazzo patterns available as well as hammered finish.

No. 888 LO-DISC TILE (24" x 24")

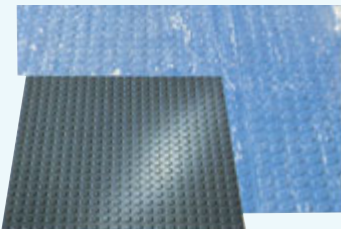

Lo-Disc design tile matches #800 Lo-Disc Treads for use on landings; has 3/4" diameter disc raised .025"; gives a safer surface for pedestrians than smooth floors. Circular discs allow easier cleaning. Meets Fed. Spec. SS-T-312B.

Specifications: Furnish and install No. 888 Lo-Disc Tile from Musson Rubber; 1/8" thick, 24" x 24" factory cut tile. Tiles shall have a continuous field pattern of 3/4" diameter discs; sanded back; contain no asbestos fiber; molded of top quality homogeneous rubber compound, color extending throughout thickness; free from objectionable odors, blisters, cracks or imperfections which might impair serviceability. Select standard color from Color Series I, II or III on page 2t.

No. 624-DL DIAMOND DESIGN TILE (24" x 24")



An ideal tile for stair landings, lobbies, aisles, ramps, elevators, concession stands, and entryways; for any high traffic area. Diamond design pattern matches diamond design stair treads in color, similar design.

Specifications: Furnish and install No. 624DL Diamond Design Tile from Musson Rubber; 7/32" thick, 24" x 24" factory cut tile. Tiles shall have a continuous field pattern of 3/4" diamonds; sanded back; contain no asbestos fiber; molded of top quality homogeneous rubber compound, color extending throughout thickness; free from objectionable odors, blisters, cracks or imperfections which might impair serviceability. Select standard color from Color Series I, II or III on page 2t.

No. 550SL SQUARE DESIGN TILE (24" x 24")



A safe, long-wearing, easily cleaned rubber floor tile for stair landings, lobbies, aisles, ramps, elevators, concession stands, and entryways. Raised design helps prevent slipping; water or dirt drops between blocks.

Specifications: Furnish and install No. 550SL Square Block Design Tile from Musson Rubber; 7/32" thick, 24" x 24" factory cut tile. Tiles shall have a continuous field pattern of 3/4" square blocks; sanded back; contain no asbestos fiber; molded of top quality homogeneous rubber compound, color extending throughout thickness; free from objectionable odors, blisters, cracks or imperfections which might impair serviceability. Select standard color from Color Series I or II on page 2t.

ADHESIVES

We carry a complete line of adhesives and nose caulks for the installation of our stair treads, risers, tile and sheet rubber.

Rubber Stair treads can be installed with our No. 400 Neoprene Contact Cement, No. 300 Stair Tread Adhesive, or No. 560 Rubber Flooring adhesive. Risers can be installed with No. 400 Neoprene Contact Cement or No. 300 Stair Tread Adhesive. Landing Tiles and sheet rubber can be installed with our No. 560 Rubber Flooring Adhesive or No. 775 Epoxy Adhesive. We do recommend that the No. 788 Disc-O-Tile only be installed with the No. 775 Epoxy Adhesive.

All rubber treads should also be installed using our No. 110 Epoxy Nose Caulk with our ECD18 or ECD26 Dual-Cartridge Dispenser.

For more information contact our sales department or visit our website at www.mussonrubber.com.

NO. 633 OUTDOOR RECYCLED RUBBER STAIR TREAD

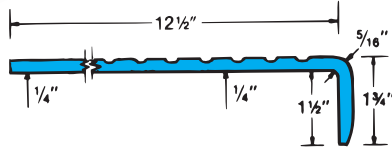
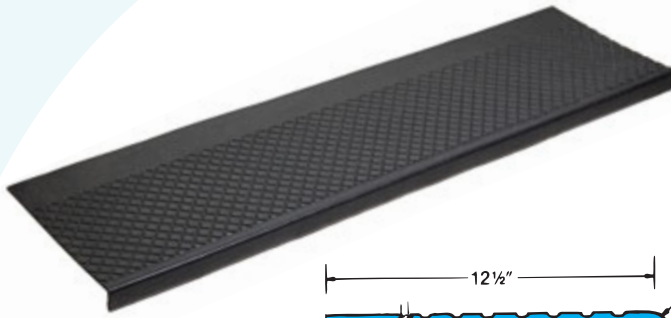

Our new No. 633 Outdoor Recycled Rubber Stair Tread is an excellent stair tread for exterior applications. This tread, made from 100% recycled tires, is available in black color only in a diamond pattern with a 3" smooth back border in square nose pattern only. This tread is also suitable for use in ice rinks and any application where spikes or cleats are worn. This tread is available 12-1/2" deep in standard lengths of 36", 42", 48", 54", 60" and 72".

Specifications: Furnish and install Musson No. 633 Outdoor Recycled Rubber Stair Treads with raised diamond pattern made from recycled tires, 1/4" thick; 12-1/2" deep as shown on drawing. Select from standard lengths of 36", 42", 48", 54", 60" or 72"; Black color only.

GRIT-SURFACE ALUMINUM STAIR TREADS

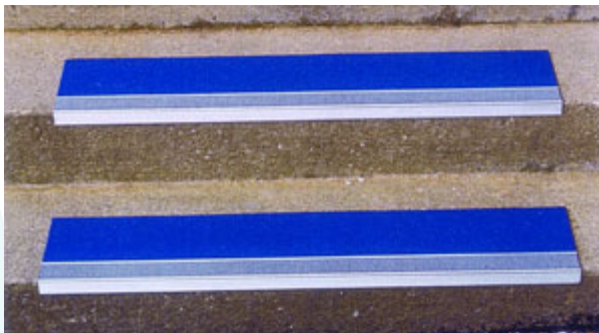

Install OUTDOORS or INDOORS on concrete, wood, treated lumber, slate or marble steps. Use for motels, schools, hotels, apartments, condos, hospitals, churches, cruise ships, amusement parks, etc. Offers anti-slip safety surface – protect new steps – renovate slippery, worn steps.

Eight Standard Colors available:
Black Brown Blue Gray
Green Red Yellow

Diamond hard aluminum oxide abrasives combined with "space-age" polymeric binders are bonded to a heat treated high strength aluminum square nose stair tread. Treads are high strength aluminum square nose stair tread. Treads are available 7-1/2", 9" or 11" deep; in one or two contrasting colors per tread. Flat pieces, 3-1/2" or 5-1/2" deep, can be used for ramps and other non-step applications or as a filler behind the 7-1/2" treads. Select one color for front insert and the same or a different color for back insert from eight standard abrasive colors of black, brown, blue, gray, green, red or yellow.

3-1/2" & 5-1/2" deep flat one color filler strips are available to butt to back of stair treads for deeper coverage or for use on flat surface or ramp installations.

Specifications: Furnish and install Musson Grit-Surface Aluminum Stair Treads, 3/16" thick; 7-1/2" (GSA75), 9" (GSA9) or 11" (GSA11) deep, as shown on drawings. Tread surface shall have aluminum oxide abrasives permanently bonded to a heat treated aluminum square nose tread. The front grit-surface of the tread shall be 5-1/2" deep, in _____ color; the back surface shall be 1/2" deep, in _____ color; colors to be separated by an aluminum rib. Select colors from standard grit colors of black, brown, blue, gray, green, red or yellow. Treads can be supplied with two countersunk holes every 12" for screw-down installation, or without holes for installation with our #400 Neoprene Contact Cement.

GRIT-SURFACE ALUMINUM NOSING

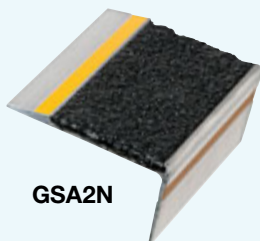

GSA2N

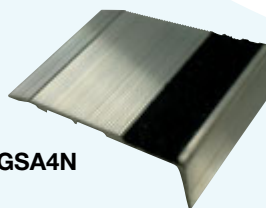

GSA4N

The GSA2N style is made from the same material as our Grit-Surface Aluminum Treads above. The nosing is 2-1/2" deep with a 1-1/4" nose. The top surface has a 1-3/4" wide abrasive finish (available in Black, Brown, Blue, Gray, Green, Red or Yellow) with a 3/4" tapered aluminum back edge. Both the nose and tapered edge have a 1/4" wide reflective yellow strip for additional safety.

The GSA4N is 3-15/16" deep with a 1-1/8" deep nose. The top surface has a 1" wide abrasive finish (same colors as the GSA2N) with a 2-7/8" ribbed aluminum back.

Both styles are available solid (for glue-down applications) or with countersunk holes (for screw down applications) every 12".

UNO-TRED ONE-PIECE TREAD & RISER

Musson Rubber Uno-Tred one-piece rubber stair tread and riser and matching 24" x 24" Uno-Tile are excellent for commercial applications such as schools, churches, hotels, restaurants, theatres, office buildings, apartments, factories, and hospitals. The one-piece tread/riser construction makes for a cleaner look than traditional two-piece installations. Available in 25 colors, these products do not contain any PVC, plasticizers, cadmium, formaldehyde, halogens or CFCs.

901 UNO-TRED

Furnish and install No. 901 Uno-Tred one-piece rubber stair tread and riser with raised disc pattern from Musson Rubber; with tapered 1.08" discs, raised .02" in standard lengths of 36", 42", 48", 54", 60", 72" or 78"; also available with two 3/4" Grit Strips (GS901) or one 2" Grit Strip (GS901VI). Select from 25 "200 Series" colors as shown.

988 UNO-TILE

Furnish and install No. 988 Uno-Tile from Musson Rubber; .14" thick, 24" x 24" tile with tapered 1.08" raised disc pattern. Select from 25 "200 Series" colors as shown.

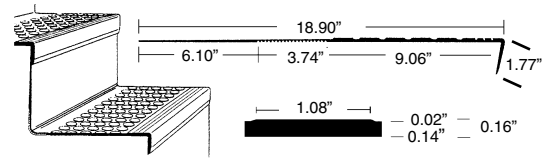

Also available with two 3/4" or one 2" Grit Strip



GS901 (two 3/4" strips)

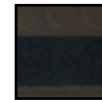

GS901VI (one 2" strip)

All Colors must Be Selected From Actual Samples



201 FOREST GREEN 202 TERRA COTTA 203 MIDNIGHT BLUE 204 BLACK 205 STEEL GRAY



206 CHARCOAL 207 CORDOVAN 208 SPRING GREEN 209 ARMY GREEN 210 MEDIUM BLUE 211 DESERT 212 MUSTARD 213 OLIVE 214 CHOCOLATE 215 SCARLET



216 WINDSOR BLUE 217 PUTTY GRAY 218 COASTAL BLUE 219 SEAFOAM GREEN 220 PEARL GRAY 221 PINE 222 BONE 223 AQUA 224 EMERALD GREEN 225 ORANGE

NEW! Square Block Pattern Uno-Tred & Uno-Tile available in a limited color line. Uno-Treds are the same specifications as round disc pattern; tiles are 500 mm x 500 mm (approximately 19-11/16"). Contact customer service for more information.



Product colors are reproduced as accurately as possible. Final color selection should be made from actual samples.

For entrance mats, matting or tile, see catalog 12 48 13/MUS in the Sweet's General Building & Renovation Catalog Files.



essentials in commercial buildings safety by:

MUSSON RUBBER CO.

1320 ARCHWOOD AVE. / AKRON, OHIO 44306 / TELEPHONE 330-773-7651

1-800-321-2381

FAX 1-330-773-3254

E-mail: info@mussonrubber.com

Visit our website at
www.mussonrubber.com

see us at
Sweets.com